











# Bipolar Power Product Selection Guide

Efficient, Reliable and Green



# Thyristors

## 4-Quadrant Triacs

$I_{T(RMS)}$ (A)	$V_{DRM}$ (V)	$I_{GT}$ (max) (mA)	SOT54 (TO92)	SOT78 (TO220AB)	SOT78D (internally insulated TO220AB)	SOT82	SOT186A (isolated TO220AB)	SOT223	SOT404 (D <sup>2</sup> PAK)	SOT428 (DPAK)
										
0.6	400	5/5/5/7	MAC97A6							
	600	5/5/5/7	MAC97A8							
	400 / 600	5/5/5/7	BT1306-D							
0.8	400 / 600	5/5/5/7	BT1308-D					BT1308W-D		
	600	5/5/5/7	Z00607MA							
1	600	3/3/3/7						BT131W		
	600 / 800	3/3/3/7	BT131							
	600 / 800	5/5/5/7	BT131-D							
	600 / 800	10/10/10/10	BT131-E							
	600 / 800	3/3/3/5	Z0103MA/NA					Z0103MN/NN		
	600 / 800	5/5/5/7	Z0107MA/NA					Z0107MN/NN		
	600 / 800	10/10/10/10	Z0109MA/NA					Z0109MN/NN		
	600 / 800	3/3/3/5	Z0103MA0/NA0**					Z0103MN0/NN0**		
	600 / 800	5/5/5/7	Z0107MA0/NA0**					Z0107MN0/NN0**		
	600 / 800	10/10/10/10	Z0109MA0/NA0**					Z0109MN0/NN0**		
4	600	5/5/5/10	BT132-D*							
	800	D/E/-/G				BT134				
	600	E/-				BT134				
	600	D/-		BT136			BT136X			BT136S
	600	F					BT136X			BT136S
	600 / 800	E		BT136			BT136X		BT136B	BT136S
	800	-					BT136X			BT136S
6	600	F/-/G					BT236X			
	800	-/G					BT236X			
8	600	D/-/G		BT137			BT137X			BT137S
	600	E		BT137			BT137X		BT137B	BT137S
	600	F					BT137X		BT137B	BT137S
	800	E		BT137			BT137X		BT137B	BT137S
	800	F						BT137B		BT137S
	800	-		BT137			BT137X		BT137B	
	800	G						BT137B		BT137S
12	600	D		BT138			BT138X			
	600	-/G		BT138			BT138X		BT138B	
	600	F					BT138X		BT138B	
	600 / 800	E		BT138	BT138Y		BT138X		BT138B	
	800	F					BT138X			
	800	-		BT138			BT138X			
16	600	E/-		BT139			BT139X		BT139B	
	600	F					BT139X		BT139B	
	600	G					BT139X		BT139B	
	800	E		BT139					BT139B	
	800	F							BT139B	
	800	-		BT139			BT139X		BT139B	
	800	G		BT139					BT139B	
20	600	50/50/50/75					MAC223A8X			
25	400	50/50/50/75		MAC223A6						
	600 / 800	-		BTA140						

$I_{GT}$  key:  
D 5 mA (10 mA in 3+)  
E 10 mA (25 mA in 3+)  
F 25 mA (70 mA in 3+)  
- 35 mA (70 mA in 3+)  
G 50 mA (100 mA in 3+)

\* Large chip / high  $I_{TSM}$   
\*\* Enhanced immunity to false triggering



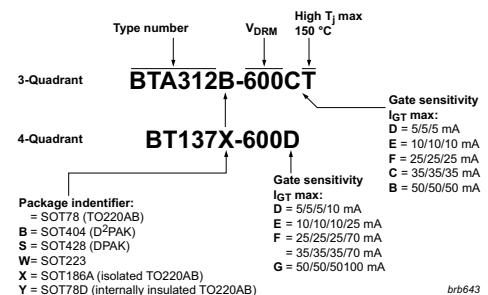

### Triacs part numbering



# Thyristors

## 3-Quadrant Triacs





types in **bold red** represent new products

$I_{T(RMS)}$ (A)	$V_{DRM}$ (V)	$I_{GT}$ (max) (mA)	SOT54 (TO92)	SOT78 (TO220AB)	SOT78D (internally insulated TO220AB)	SOT186A (isolated TO220AB)	SOT223	SOT404 (D <sup>2</sup> PAK)	SOT428 (DPAK)
									
0.8	600 / 800	D/E	BTA2008						
1	600 / 800	B/E/ER	BTA201						
	600 / 800	E					BTA201W		
2	600 / 800	D/E							
	600	B/C/D/E/F		BTA204		BTA202X			BTA204S
	800	B/C/E		BTA204		BTA204X			BTA204S
4	1000	C				<b>BTA204X</b>			<b>BTA204S</b>
	600	B/D/E/F		BTA208		BTA208X			BTA208S
	800	B/E		BTA208		BTA208X			BTA208S
	800	F		<b>BTA208</b>		BTA208X			<b>BTA208S</b>
	1000	B				BTA208X			
	1000	C				BTA208X		BTA208B	
	1000	5 min - 35 max				BTA208X-1000C0			
12	600	D		BTA312		BTA312X		BTA312B	
	600	CT		BTA312				BTA312B	
	600 / 800	B/C/E		BTA312		BTA312X		BTA312B	
	600 / 800	C			BTA312Y				
	800	ET		BTA312				BTA312B	
16	600 / 800	B/C			BTA412Y				
	600	BT/D		BTA316					
	600 / 800	B/C/E		BTA316		BTA316X		BTA316B	
	600 / 800	ET		BTA316					
	800	10 min - 50 max				<b>BTA316X-800B0</b>			
25	600 / 800	B/C			BTA416Y				
	600	BT		BTA225					
	600 / 800	B		BTA225				BTA225B	

$I_{GT}$  key:  
D 5 mA (10 mA in 3+)  
E 10 mA (25 mA in 3+)  
F 25 mA (70 mA in 3+)  
- 35 mA (70 mA in 3+)  
G 50 mA (100 mA in 3+)

## Silicon Controlled Rectifiers

types in **bold red** represent new products



$I_{T(RMS)}$ (A)	$V_{DRM}$ & $V_{RRM}$ (V)	$I_{GT}$ (max) (mA)	SOT54 (TO92)	SOT78 (TO220AB)	SOT82	SOT186A (isolated TO220AB)	SOT223	SOT404 (D <sup>2</sup> PAK)	SOT428 (DPAK)	SOT533 (IPAK)
										
0.8	400	0.012	EC103D1							
	400 ( $V_{DRM}$ only)	0.2	NXL0840							
	200 / 400 / 600	0.2	BT149B/D/G							
	200 / 400 / 600	0.2	BT169B/D/G							
	400	0.05	BT169D-L							
	800	0.1	BT169H							
	500 / 600	0.02 min - 0.2 max	BT168E/G							
1	200	0.2					MCR08BT1			
	600	0.02 min - 0.2 max					BT168GW			
	600	0.07 min - 0.45 max					<b>BT168GWF**</b>			
	600	0.2					BT148W-R*			
4	400 / 500 / 600	0.2			BT148-R					
	600	0.2							BT150S-R	
	500	0.2		BT150-R						
8	800	0.05							BT258S-LT	
	500 / 600 / 800	0.2		BT258-R		BT258X-R				
	600	0.2								BT258U-R
	800	0.2							BT258S-R	
12	500 / 650	5		BT151-L					BT300S-R	
	500 / 650 / 800	15		BT151-R		BT151X-R			BT151S-L	
	650	15							BT151S-R	
	500 / 650 / 800	15		BT151-C		BT151X-C			BTH151S-R	
	500 / 1000	15		<b>BT151-RT</b>						
20	400 / 600 / 800	32		BT152-R		BT152X-R		BT152B-R		
	500	32		<b>BT152-RT</b>						
25	800	35		BT145-R						

\* Large chip / high  $I_{TSM}$   
\*\* Hi-Com / fast turn-off  
T: high  $T_{max}$  150 °C

# Thyristors

## AC Thyristors



types in **bold red** represent new products

$I_{T(RMS)}$ (A)	$V_{DRM}$ (V)	$I_{GT}$ (max) (mA)	SOT54 (TO92)	SOT223	SO8
0.2	600	D			
0.8	600	D	<b>ACT108</b>	<b>ACT108W</b>	
	600	E	ACT108	ACT108W	

$I_{GT}$  key:  
D = 5 mA  
E = 10 mA

## AC Thyristor Triacs

types in **bold red italic underline** represent products in development

$I_{T(RMS)}$ (A)	$V_{DRM}$ (V)	$I_{GT}$ (max) (mA)	SOT186A	SOT428
2	800	E		
			<b><u>ACTT2X</u></b>	<b><u>ACTT2S</u></b>

$I_{GT}$  key:  
E = 10 mA

# High Voltage Power Bipolar Transistors

## High Voltage Power Bipolar Transistors for lighting, SMPS and industrial applications

types in **bold red** represent new products

$V_{CESM}$ (V)	$I_{C(DC)}$ (max) (A)	25 °C ind. $t_f$ (typ) (ns)	@ $I_C$ (A)	$h_{FE}$ (typ)	@ $I_C$ (A)	SOT54 (TO92)	SOT78 (TO220AB)	SOT186A (isolated TO220AB)	SOT404 (D <sup>2</sup> PAK)	SOT428 (DPAK)	
700	1	80	1	7.5	0.8	BUJ100LR					
	1	80	1	7.5	0.8	PHE13003A					
	1	50	1	14	0.75	BUJ100					
	1.5	100	0.5	9	1	PHE13003C					
	1.5	100	0.5	9	1	PHD13003C*					
	4	30	2	12.5	3		BUJ103A	BUJ103AX		BUJ103AD	
	4	30	2	12.5	3					BUJD103AD*	
	4	100	2	17	2			PHE13005	PHE13005X		
	4	100	2	17	2			PHD13005*			
	8	20	5	11	4			BUJ105A		BUJ105AB	BUJ105AD
	8	20	5	11	4						BUJD105AD*
	8	40	5	9	5			PHE13007			
10	20	5	11	6			BUJ106A				
12	100	5	6 min - 30 max	8			PHE13009				
850	4	30	2	12.5	3		<b>BUJD203A*</b>	<b>BUJD203AX*</b>		<b>BUJD203AD*</b>	
1000	5	145	2.5	12	3		BUJ303A	<b>BUJ303AX</b>		<b>BUJ303AD</b>	
1050	4	520	2	41	0.8		<b>BUJ302A</b>	<b>BUJ302AX</b>		<b>BUJ302AD</b>	
	5	200	2.5	10.5	3		BUJ303B				
1200	6	170	2.5	15.5	3		BUJ403A				

\*Integrated freewheeling diode  
Package drawings are not to scale



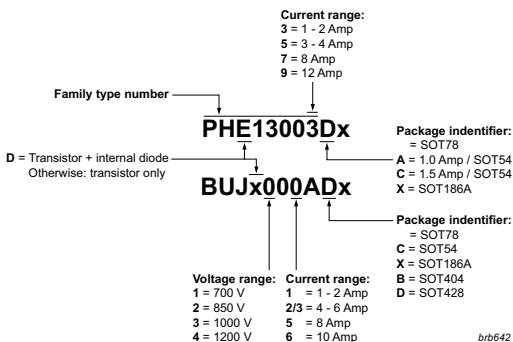

## PHx/BUJx series part numbering



# Power Diodes

## Hyperfast power diodes









types in ***bold red italic underline*** represent products in development

V <sub>RRM</sub> (V)	I <sub>F(AV)</sub> (A)	V <sub>F</sub> (typ) @ 150C (V)	@ I <sub>F</sub> (A)	t <sub>rr</sub> (typ) @ 25C (ns)	SOD59 (TO220AC)	SOD113 (2-pin SOT186A)	SOT78 (TO220AB)	SOT404 (D <sup>2</sup> PAK)
								
600	5	1.4	5	19	BYC5-600	BYC5X-600		BYC5B-600
	8	1.4	8	19	BYC8-600	BYC8X-600		BYC8B-600
	8	1.4	8	19	<b><i>BYC8D-600</i></b>	<b><i>BYC8DX-600</i></b>		
	8	2	8	12.5		BYC58X-600		
	10	1.4	10	19	BYC10-600	BYC10X-600		BYC10B-600
	2 x 5	1.4	5	19			BYC10-600CT	
	15	1.4	15	19	BYC15-600	BYC15X-600		
20	1.4	20	19	BYC20-600	BYC20X-600			

# Power Diodes

## Ultrafast power diodes

types in **bold red** represent new products

V <sub>RRM</sub> (V)	I <sub>F(AV)</sub> (A)	V <sub>F</sub> (typ) @ 150C (V)	@ I <sub>F</sub> (A)	t <sub>rr</sub> (typ) @ 25C (ns)	SOD59 (TO220AC)	SOD113 (2-pin SOT186A)	SOT78 (TO220AB)	SOT186A (isolated TO220AB)	SOT223	SOT226 (I <sup>2</sup> PAK)	SOT404 (D <sup>2</sup> PAK)	SOT428 (DPAK)
												
100	8	0.8	8	20	BYW29E-100							
	2 x 10	0.72	8	20			BYV32E-100					
150	2 x 0.75	0.5	0.5	10					BYV40E-150			
	8	0.8	8	20	BYW29E-150							
	2 x 10	0.72	8	20			BYV32E-150					
200	2 x 15	0.78	15	20			BYV42E-150					
	8	0.8	8	20	BYW29E-200	BYW29EX-200						BYW29ED-200
	2 x 5	0.8	5	15			BYQ28E-200	BYQ28X-200				BYQ28ED-200
	14	0.83	14	20	BYV79E-200							
	2 x 8	0.84	8	20			BYQ30E-200					
	2 x 10	0.72	8	20			BYV32E-200				<b>BYV32G-200</b>	BYV32EB-200
	2 x 15	0.78	15	20			BYV42E-200				<b>BYV42G-200</b>	BYV42EB-200
300	2 x 5	0.95	5	50			BYT28-300					
400	9	0.9	8	50	BYV29-400							
	2 x 10	0.87	10	50			BYV34-400					
500	9	0.9	8	50	BYV29-500	BYV29X-500					BYV29B-500	
	2 x 5	0.95	5	50			BYT28-500					
	15	0.9	15	50	BYT79-500							
	2 x 10	0.87	10	50			BYV34-500					
	2 x 15	0.95	15	50			BYV44-500					
600	5	0.97	5	50		BYV25X-600				BYV25G-600		BYV25D-600
	8	1.07	8	60	BYR29-600	BYR29X-600						
	9	0.97	8	50	BYV29-600	BYV29X-600				BYV29G-600	BYV29B-600	
	15	1	15	50	BYT79-600	BYT79X-600						
	2 x 10	0.92	10	50			BYV34-600	BYV34X-600		BYV34G-600		
	5	1.1	5	17.5	<b>BYV25F-600</b>	<b>BYV25FX-600</b>	BYV25F-600				BYV25FB-600	<b>BYV25FD-600</b>
	9	1.25	8	17.5	<b>BYV29F-600</b>	BYV29FX-600	BYV29F-600				BYV29FB-600	<b>BYV29FD-600</b>
2 x 10	1.3	10	20			BYV410-600	BYV410X-600					
800	8	1.07	8	60	BYR29-800	BYR29X-800						

## Power Diode part numbering

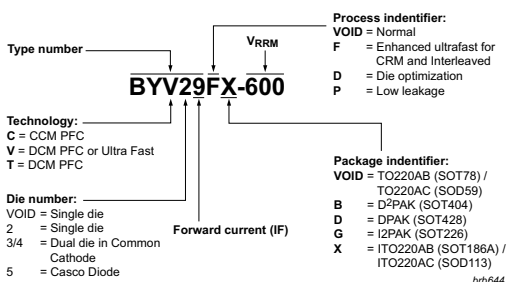



[www.nxp.com](http://www.nxp.com)

© 2011 NXP Semiconductors N.V.

All rights reserved. Reproduction in whole or in part is prohibited without the prior written consent of the copyright owner. The information presented in this document does not form part of any quotation or contract, is believed to be accurate and reliable and may be changed without notice. No liability will be accepted by the publisher for any consequence of its use. Publication thereof does not convey nor imply any license under patent- or other industrial or intellectual property rights.

Date of release: March 2011

Document order number: 9397 750 17064

Printed in the Netherlands